

Design of Computer Control for Manufacturing Systems

Yoram Koren

ASME Transactions J. Eng. For Industry, Volume 101, Number 3, Aug 1979, pp. 326-332

Obtained from Professor Yoram Koren's Site:

<http://sitemaker.umich.edu/ykoren>

Direct Link to Paper:

http://www-personal.umich.edu/~ykoren/uploads/Design_of_Computer_Control_for_Manufacturing_Systems.pdf



an ASME
publication

\$3.00 PER COPY \$1.50 TO ASME MEMBERS

The Society shall not be responsible for statements or opinions advanced in papers or in discussion at meetings of the Society or of its Divisions or Sections, or printed in its publications. Discussion is printed only if the paper is published in an ASME journal or Proceedings. Released for general publication upon presentation. Full credit should be given to ASME, the Technical Division, and the author(s).

50, Trans. ASME. J. Eng. Ind. Vol. 101 No. 3 pp. 326-332 Aug. 1979

Y. Koren

Faculty of Mechanical Engineering, Technion—
Israel Institute of Technology, Haifa, Israel.

Design of Computer Control for Manufacturing Systems

An analysis is presented of computerized numerical control (CNC) for manufacturing systems. Two types of CNC systems referred to as Reference-Pulse and Sampled-Data are discussed. In the first system, reference pulses are generated by the computer and supplied to an external digital control loop. With the Sampled-Data technique, the computer serves as a comparator of the control loop and transmits the position error at fixed time intervals. The basis for selection of the particular type of CNC system and the required system parameters are given.

Introduction

An important advance in the philosophy of numerical control (NC) of machine tools, which took place during the early 1970's, was the shift towards the use of computers instead of controller units in NC systems. This produced both computer numerical control (CNC) and direct numerical control (DNC) [1]. CNC is a self-contained NC system for a single machine tool including a dedicated mini-computer controlled by stored instructions to perform some or all of the basic numerical control functions. With DNC, several machine tools are directly controlled by a central computer.

Of the two types of computer control, CNC has become much more widely used for manufacturing systems (e.g., machine tools, welders, laser-beam cutters) mainly because of its flexibility and the lower investment required. The preference for CNC over DNC is continuing to become even greater due to the availability and declining costs of minicomputers and microprocessors. In spite of this interest in CNC for manufacturing systems, very little has been published on the subject, as each manufacturer separately develops his own system technology. It is the purpose of this paper to describe the basic CNC concepts and develop a basis for selecting the appropriate type of CNC system and the system parameters according to the requirements of the manufacturing process.

CNC Concepts

A block diagram of a closed-loop CNC system is shown in Fig. 1. As compared with conventional NC, CNC makes extensive use of software in place of hardware. The software of a CNC system consists of at least three major programs: a part-data program, a service program, and a control program. The part-data program contains a de-

scription of the geometry of the part being produced and the cutting conditions such as spindle speed and feed-rate. Dimensions in part-data programs are expressed by integers in units corresponding to the position resolution of each axis-of-motion. This unit is referred to henceforth as the "basic length-unit" (BLU), which might be on the order of 10 μm in a typical machine tool system. The service program is used to check, edit, and correct the part-data program. The control program accepts the part-data program as input and produces signals to drive the axes-of-motion.

In all types of CNC systems the control program performs interpolation, feed-rate control, deceleration and acceleration, and contains position counters which show the incremental distance to the end of the current segment along the required path. The main routine in the control program is the interpolator, which coordinates the motion

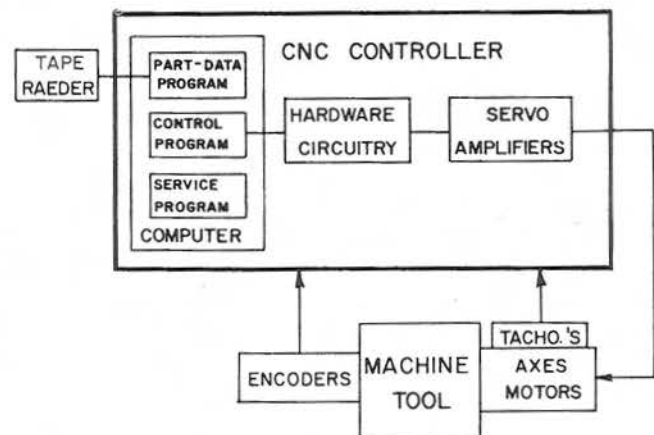

Fig. 1 Illustration of a closed loop CNC system

Contributed by the Production Engineering Division for presentation at the Winter Annual Meeting, San Francisco, Calif., December 10-15, 1978 of THE AMERICAN SOCIETY OF MECHANICAL ENGINEERS. Manuscript received at ASME headquarters July 25, 1978. Paper No. 78-WA/PROD-14.

Copies will be available until Sept. 1979.

along the machine axes, which are separately driven, to generate the required machining path. The machining path is usually obtained from a combination of linear and circular segments and accordingly the control program contains a linear and a circular interpolation subroutine.

Most closed-loop CNC systems include both velocity and position control loops, the velocity feedback provided by a tachogenerator and the position feedback by an encoder or other digital device (see Fig. 1). The tachogenerator provides a voltage proportional to the velocity and the encoder emits voltage pulses, each corresponding to an axis displacement of one BLU.

The computer output in CNC systems can be transmitted either as a sequence of reference pulses or as a binary word in a sampled-data system. With the first technique, the computer produces a sequence of reference pulses for each axis-of-motion, each pulse generating a motion of one BLU of axis travel. The number of pulses represents position and the pulse frequency is proportional to the axis velocity. These pulses can actuate a stepping motor in an open-loop system or be fed as a reference to a closed-loop system. With the Sampled-Data technique, the control loop is closed through the computer itself. The control program compares a reference word with the feedback signal to determine the position error. This error signal is fed at fixed time intervals to a digital-to-analog converter (DAC), which in turn supplies a voltage proportional to the required axis velocity.

In designing a CNC system for a particular application, the first step is to determine whether the Reference-Pulse technique or Sampled-Data technique is most appropriate. It will be seen that the choice is constrained in most cases by the velocity and system response requirements. Once a technique is selected it is subsequently necessary to specify the appropriate system parameters. The remainder of this paper is concerned with these design considerations.

Reference-Pulse Technique

A block diagram of a single axis CNC system using the Reference-Pulse technique is presented in Fig. 2. In a practical multi-axes system, each axis-of-motion is controlled by an identical control loop connected to the computer by two pulsed lines, one for clockwise and the other for counterclockwise motion. The computer contains the control program which accepts the part-data as input and produces the reference pulses to the control loop. The "machine drive" block in Fig. 2 includes the axis motor, tachogenerator, and servo-amplifier as shown in Fig. 1.

The digital encoder in Fig. 2 is the feedback device and the up-down counter is a comparator element fed by two sequences of pulses: reference pulses from the computer and feedback pulses from the encoder. The pulse-number difference between the two inputs is the position error, which is converted to a voltage by a DAC to drive the axis motor [2, 3]. The motor rotates in the direction which reduces the error. For example, if a constant reference frequency is supplied by the computer, the encoder frequency in the steady-state is identical to the reference frequency, except for a finite pulse and phase difference which is necessary to generate the corrective error voltage to rotate the motor. An alternative method uses a resolver as the feedback device and a phase-comparator, or a discriminator, to compare

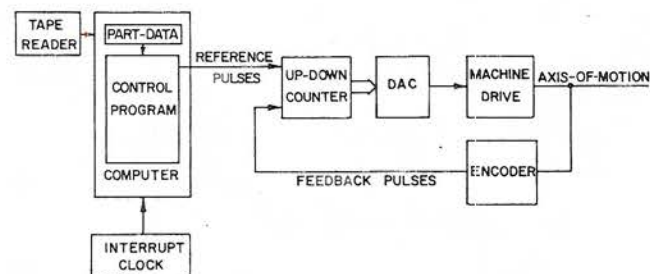

Fig. 2 Block diagram of a Reference-Pulse CNC system

the reference and the feedback signals [4-6]. In either case, the input to the control loop is a sequence of reference pulses, each pulse generating a motion of one BLU, so that the axis velocity is proportional to the pulse frequency and its position proportional to the number of transmitted pulses.

The interpolator in Reference-Pulse systems is based upon an iterative technique controlled by an external interrupt clock. At each interrupt a single iteration of the interpolator routine is executed, which in turn can provide an output pulse of one BLU to one or more axes. The maximum output pulse-rate is obtained when each iteration produces an output pulse, so that the interrupt frequency f_m for a maximum velocity is

$$f_m = \frac{V_m}{BLU} \quad (1)$$

where V_m is the maximum axis velocity (BLU/time).

The maximum allowable interrupt rate depends on the execution time of a single iteration of the interpolator routine. With present-day technology [5, 7], the execution time t_e is approximately 100 μ sec, which in turn yields a maximum interrupt frequency of

$$f_m = \frac{1}{t_e} = 10^4 \text{ (pulses/sec)} \quad (2)$$

This is also the maximum frequency of reference pulses in interpolated motions. It should be noted that when applying rapid traverse motions which do not require coordination between axes-of-motion, the major portion of the interpolator routine is bypassed and, therefore, the frequency of the reference pulses can be two or three times faster than that given by equation (2). Combining equations (2) and (1) gives the relationship between the system BLU and the maximum axis velocity which can be achieved by the Reference-Pulse technique. If the maximum velocity requirement exceeds this limit, it will be necessary to use the Sampled-Data technique.

In principle, the Reference-Pulse technique should be treated mathematically as a discrete-time system with non-uniform sampling, in which the continuous motion of the axis is monitored from pulses emitted K_e times per revolution of the encoder. In practice, however, since K_e is relatively large (e.g., 1000 pulses/rev), the Reference-Pulse system can be analyzed as a continuous system, to which the Laplace transform technique can be applied for analyzing the design requirements. The transfer function of the machine drive can be modelled as a simple first-order system:

$$G_1(s) = \frac{K_m}{1 + s\tau} \quad (3)$$

where τ is the mechanical time constant of the loaded motor and K_m is the drive constant given in velocity units per volt. The up-down counter in Fig. 2 converts frequencies to a pulse-number and phase difference, both being the integral of frequency. Therefore, the counter functions as an integrator in the loop, and its transfer function is given by:

$$G_2(s) = 1/s \quad (4)$$

The open-loop gain of the system is:

$$K = K_c K_m K_e \quad (5)$$

where K_c is the DAC gain (volt/pulse) and K_e is the encoder gain (pulse/rev). Combining equations (3-5) gives the open-loop transfer function

$$G_0(s) = \frac{K}{s(1 + s\tau)} \quad (6)$$

and consequently the closed-loop transfer function is

$$G(s) = \frac{K}{\tau s^2 + s + K} \quad (7)$$

It is seen from equation (7) that the closed loop behaves as a second order servo system with the characteristic equation:

$$s^2 + 2\zeta\omega_n s + \omega_n^2 = 0 \quad (8)$$

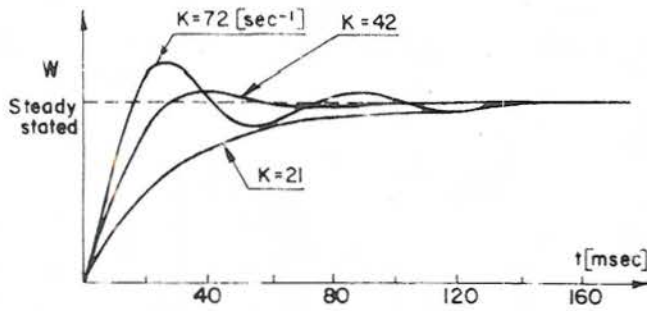

Fig. 3 Measured Responses of a Reference-Pulse CNC system with various gains to a step input

where the damping factor is:

$$\zeta = 1/(2\sqrt{K\tau}) \quad (9)$$

and the natural frequency is

$$\omega_n = \sqrt{K/\tau} \quad (10)$$

Since the open-loop system contains an integrator, the steady-state velocity error of the closed-loop system to a "step" input is zero. A step input in the Reference-Pulse system means a constant reference frequency supplied by the computer. Typical velocity responses for various open-loop gains taken on an actual CNC drive with $\tau = 12.5$ msec are given in Fig. 3. Notice that although the steady-state error is always eliminated, the maximum overshoot is increased with the open-loop gain. By decreasing the gain, the maximum overshoot can be reduced at the expense of having a longer settling time. Selecting the open-loop gain as

$$K = \frac{1}{2\tau} \quad (11)$$

has been shown to give satisfactory performance with contouring systems [3]. This results in a damping factor $\zeta = 0.707$ which is regarded as optimal for many control systems.

Sampled-Data Technique

The Sampled-Data CNC system used the computer as part of the control loop by replacing the up-down hardware counter in Fig. 2 with a software comparator [8, 9]. A block diagram of the sampled-data system for a single axis is presented in Fig. 4. The computer samples the feedback signal at a constant frequency f_s and compares it with a reference produced by the interpolator. The resulting error is the computer output which is transmitted at a uniform rate through a digital-to-analog converter (DAC) to the drive motor. Although a digital encoder is used in the system illustrated in Fig. 4, a resolver or an inductosyn could be substituted. The required interface circuitry will depend upon the hardware chosen. With a digital encoder the interfacing is simplest, consisting of a small counter which is incremented by the pulses received from the encoder. The computer samples the contents of the counter at fixed time intervals T and immediately clears it. Since each pulse from the encoder is equivalent to one BLU, the number transferred from the counter to the computer is equal to the incremental axis displacement in BLU's during the last period T .

The control program is based upon an iterative technique which is executed at the sampling rate f_s , where $f_s = 1/T$. Since the Sampled-Data technique applies a complicated interpolation routine, the execution time of a single iteration in a Sampled-Data system is much longer than that obtained by the Reference-Pulse technique. At each iteration, the contents of the counter ΔP are accumulated in the control program

$$P(n) = P(n-1) + \Delta P(n) \quad (12)$$

where P represents the actual position of the axis-of-motion in BLU's

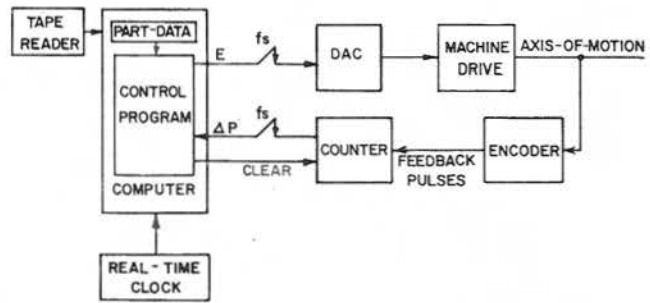

Fig. 4 Block diagram of a Sampled-Data CNC system

and is subtracted from the reference R to generate the position error E :

$$E(n) = R(n) - P(n) \quad (13)$$

The error is converted by the DAC and fed to the machine drive. R is the position reference and is related to the required velocity, V , by

$$R(n) = R(n-1) + K_e TV(n) \quad (14)$$

Equations (12-14) yield an alternative method to calculate the error:

$$E(n) = E(n-1) + K_e TV(n) - \Delta P(n) \quad (15)$$

The value of $TV(n)$ is determined on-line by the interpolator routine. Equation (15) presents an iterative process for carrying out numerical integration within the control loop, and consequently the steady-state velocity error of the closed-loop to a step input is zero.

The velocity response $W(n)$ of the axis to a step reference of V units is given by [10]

$$W(n) = V[1 - e^{-n\alpha T}(\cos n\omega T + M \sin n\omega T)] \quad (16)$$

where

$$\alpha T = -\ln(a) \quad (17)$$

and

$$\omega T = \arccos\{[1 + X - KT + K\tau(1 - X)]/2a\} \quad (18)$$

The parameters X , a and M are defined by

$$X = e^{-T/\tau}$$

$$a^2 = X + K[\tau(1 - X) - TX]$$

$$M = \frac{(1 - X)(1 + K\tau) - KT}{2a \sin \omega T}$$

The damping factor in the Sampled-Data system is given by

$$\zeta = \frac{\alpha T}{\sqrt{(\alpha T)^2 + (\omega T)^2}} \quad (19)$$

Equation 16 shows that at the steady-state $W(n) = V$, and the rate at which the steady-state value is approached is directly dependent on how quickly the term $e^{-n\alpha T}$ goes to zero which, in turn, depends on K and T . For small K and large T the step response approaches its steady-state value slowly (a sluggish system). On the other hand, if K is too big the system will oscillate before approaching the steady-state value. This behavior can be seen in Fig. 5 which shows the step response and the position error E of a Sampled-Data system with a big open-loop gain of $K = 65 \text{ sec}^{-1}$. This result was obtained on a hybrid computer with the machine drive simulated according to equation (3) and with time constant $\tau = 10$ msec and sampling frequency $f_s = 50$ Hz.

One of the prime considerations in using a Sampled-Data system is choosing the sampling period T and the open-loop gain K . There

is always a trade-off between T and K : a longer sampling period requires lower gain in order to maintain a given level of performance. One performance criterion proposed for Sampled-Data systems with step inputs is minimization of the integral of the absolute-value of the error (IAE) [10]:

$$IAE = \int_0^{\infty} |E(t)| dt \quad (20)$$

This criterion takes into account the two contrary design requirements of servo systems, namely, small overshoots on the one hand and minimum steady-state position errors on the other.

The optimal locus which minimizes the IAE in equation (20) is included in Fig. 6 [10]. Selection of the working point on this optimal locus depends upon the time constant τ . It is known from the Sampling Theorem that sampling rate should be at least twice as fast as the highest frequency ω_0 contained in the sampled signal:

$$\frac{1}{T} = f_s \geq 2 \left(\frac{\omega_0}{2\pi} \right) = \frac{\omega_0}{\pi} \quad (21)$$

The machine drive of the CNC Sampled-Data system behaves like a low-pass filter with a critical frequency of $\omega_c = 1/\tau$, as can be seen from equation (3). Substituting $\omega_0 > \omega_c$ in equation (21) yields the necessary condition for selecting the sampling period:

$$\frac{T}{\tau} < \pi \quad (22)$$

The effect of T is illustrated in Fig. 7 which shows the step response of a simulated CNC system with $\tau = 20$ msec with two sets of K and T which lie on the optimal locus of Fig. 6. A step torque is applied at $t = 0.1$ sec, which might simulate the start of a machining process. With $T/\tau = 0.5$, the response is smooth and fast, but with $T/\tau = 2.0$ the performance is poorer because the system needs a longer time to recover from the torque disturbance and the motion is rougher. For systems we have studied, satisfactory performance has been obtained with

$$\frac{T}{\tau} \approx \frac{\pi}{4} \quad (23)$$

which satisfies the condition in equation (22) and also assures that the signal's energy loss is less than 15 percent while sampling [11].

It is generally believed [11] that better performance can be obtained by using a smaller sampling period, as this transfers more information. However, if T is too small and the encoder frequency is also small, feedback pulses are not sensed by the computer. Since each pulse provided by the encoder is equivalent to one BLU of axis travel, its output frequency f is given by

$$f = W/BLU \quad (24)$$

where W is the actual axis velocity. The average number of pulses fed to the counter in Fig. 4 during the sampling period T is

$$\overline{\Delta P} = Tf = f/f_s \quad (25)$$

In practice, ΔP is an integer number as is seen in Fig. 7. So for $f/f_s < 1$ no pulses are counted (the reading of the counter is zero) during some periods T . For example, a value of $f/f_s = 0.1$ means that $\Delta P = 0$ for nine out of ten samples and $\Delta P = 1$ for the tenth one. During periods with $\Delta P = 0$, no feedback signal is received by the computer, thus leaving the loop open and unable to accommodate any disturbances. Since the frequency f_s is fixed according to equation (23), the ratio f/f_s depends only upon f . As a consequence, a Sampled-Data CNC system is not suitable for small f . We have found that adequate range of velocities can be obtained with:

$$f_m/f_s \geq 100 \quad (26)$$

where f_m is given by equation (1) and is equal to the encoder frequency for the maximum required velocity V_m .

The use of $f_m/f_s \approx 100$ is also an appropriate lower limit when considering the interfacing with the computer. Typically minicomputers are using a 16-bit word and micro-processors an 8-bit word.

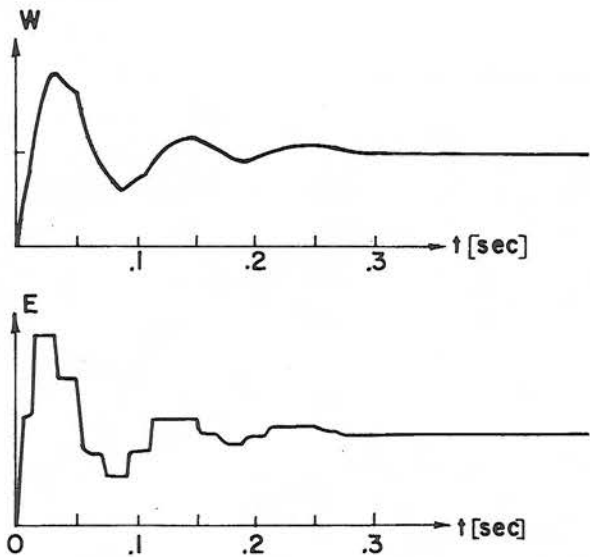

Fig. 5 Response and error of a Sampled-Data system with too high gain

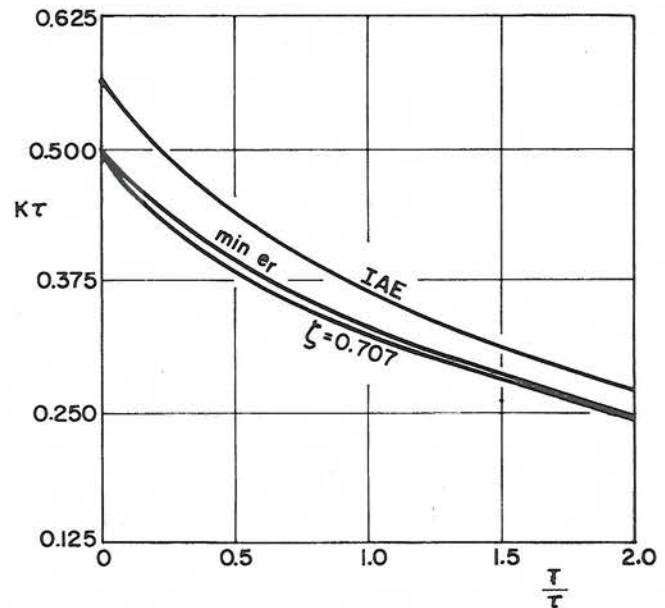

Fig. 6 Optimal loci of Sample-Data systems according to IAE, minimum radial error ($\min er$), and $\zeta = 0.707$

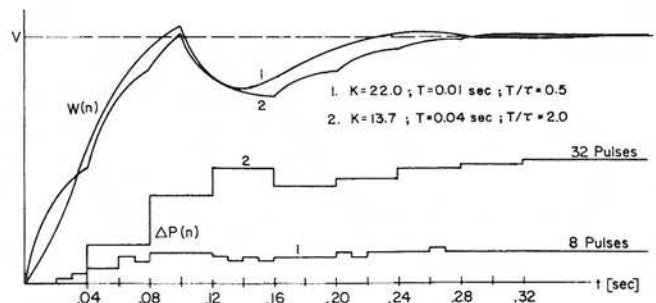

Fig. 7 Responses and counter readings of a simulated Sampled-Data system

To accommodate this word size, the counter associated with the encoder consists of 8 bits. This allows computer access to the whole counter at the same time in a microprocessor-based control system, and to two counters simultaneously in a biaxial minicomputer-based CNC system. One bit of the eight is reserved as a sign bit to indicate the direction of motion, and the other seven bits are used to count the encoder pulses, permitting a maximum reading of $2^7 = 128$ pulses per sample. This is close to the value of 100 given above. It is therefore desirable to operate near this lower limit.

Combining equations (23) and (26) leads to the requirement for design of a Sampled-Data system:

$$\tau f_m \geq 400/\pi. \quad (27)$$

The term τf_m is the axis travel in BLU's in time τ . Note that a small sampling period below the value given in equation (23) results in a tighter constraint.

Optimization for Circular Motion

Up to this point, the system design has been considered for the case of linear motion. However, CNC manufacturing systems also require non-linear motion which is generated as a combination of lines and circles.

Circular curves are generated in CNC systems by feeding sinusoidally varying references into the control loops, but the control loops do not follow the sinusoidally inputs perfectly with zero error along each axis. Since a plane circular path is generated by the simultaneous motion of two axes, the radial error depends on the axial errors, which in turn become greater with faster angular velocities. It has been shown [10] that the steady-state radial error with a Sampled-Data CNC system can be written:

$$\frac{e_r}{r} = \frac{L}{2} (\omega T)^2 + \frac{N}{2} (\omega T)^4 \quad (28)$$

where r is the radius of the circle, ω is the angular velocity, and the parameter L is given by

$$L = \frac{K\tau(T/\tau + 2) - 1}{(KT)^2} \quad (29)$$

The parameter N also depends on K , T and τ . Since in practice $\omega T \ll 1$, the term containing N becomes negligible except when $L = 0$.

For a given circular path, the maximum radial error e_{rm} occurs at the maximum path velocity V_m corresponding to the angular velocity

$$\omega_m = V_m/r = (BLU)f_m/r \quad (30)$$

Combining this with equation (28) and neglecting the second term leads to

$$\frac{e_{rm}}{BLU} = \frac{L}{2} (Tf_m)^2 \frac{BLU}{r} \quad (31)$$

In order to keep the diametral error within one BLU, the radial error should not exceed $\frac{1}{2} BLU$ so that

$$r/BLU > L(Tf_m)^2 \quad (32)$$

Therefore the error constraint leads to a limit on the minimum allowable radius, which is expressed here in BLU units as a function of $K\tau$, T/τ and τf_m for a Sampled-Data system. With $Tf_m = 100$, as suggested above, and introducing the minimum IAE criterion from Fig. 6, the minimum allowable radius can be more simply expressed as a function of a single parameter, e.g., τf_m . This result is included in Fig. 8.

The minimum radius in a system applying the Reference-Pulse technique is obtained by substituting $T = 0$ in equation (32) which yields

$$r/BLU > (2K\tau - 1)(f_m/K)^2 \quad (33)$$

For $T = 0$ the minimum IAE criterion results in the value of $K\tau = 0.567$ as the optimal, and consequently equation (33) is reduced to

$$r/BLU > 0.4(\tau f_m)^2 \quad (34)$$

The corresponding minimum radius has been obtained and is also included in Fig. 8.

In many practical CNC systems the minimum allowable radius according to the minimum IAE criterion is too large. Consider, for example, a Sampled-Data system with a resolution $BLU = 0.01$ mm and a maximum velocity $V_m = 6$ m/min. The corresponding f_m according to equation (1) is 10,000 pulses/sec. For a typical time-constant of 20 msec the parameter τf_m becomes 200 and the corresponding minimum radius, according to Fig. 8, is 219 mm (8.6 inch). Therefore, the minimum IAE criterion and the corresponding design procedure is restricted to systems requiring essentially linear motions. For CNC systems which require both linear and circular motions, a different design criterion is necessary.

An alternative optimization criterion for design of CNC systems which include a circular interpolator could be minimization of the radial error. For a Sampled-Data system, the radial error is given by equation (28). In practice $\omega T \ll 1$ and the first term will usually give the major contribution to the total radial error. This first term can be eliminated, and therefore near-optimal performance can be simply obtained by setting $L = 0$, which from equation (29) leads to:

$$K\tau(T/\tau + 2) = 1 \quad (35)$$

This result is shown as the curve designated "min e_r " in Fig. 6. It can be seen in Fig. 8 that this criterion allows for much smaller radii of curvature than the minimum IAE criterion.

The analysis for a Reference-Pulse system can be carried out by setting $T = 0$. In equation (35), this leads to:

$$K = \frac{1}{2\tau} \quad (36)$$

which is identical to equation (11) and therefore corresponds to having a damping factor $\zeta = 0.707$. The radial error for a Reference-Pulse system can be written as [12]

$$\frac{e_r}{r} = 1 - \frac{1}{\sqrt{1 + (2\zeta\omega/\omega_n)^2 - 2(\omega/\omega_n)^2 + (\omega/\omega_n)^4}} \quad (37)$$

By combining equations (9), (10), (36) and (37), the minimum radial error becomes

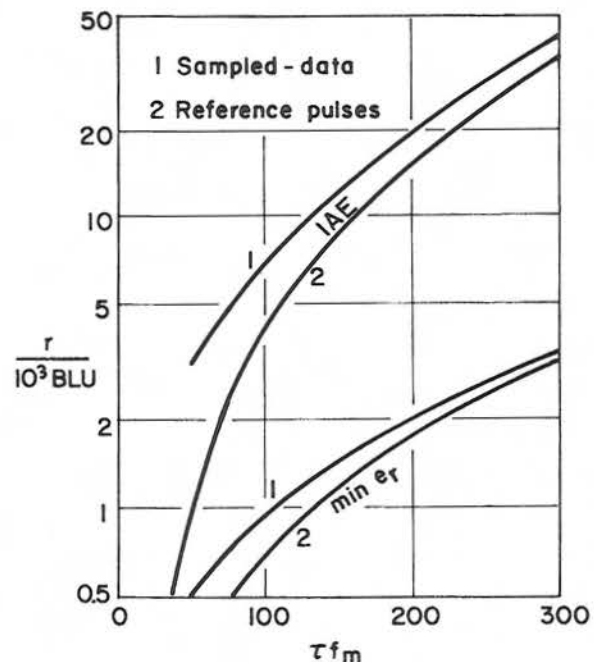

Fig. 8 Minimum allowable radii in CNC systems for various design criteria

$$\frac{e_r}{r} = 1 - \frac{1}{\sqrt{1 + 4(\omega\tau)^4}} \approx 2(\omega\tau)^4 \quad (38)$$

Substituting the maximum value of ω from equation (30) and limiting the radial error to $1/2$ BLU, the minimum allowable radius is:

$$r/BLU = 4(\tau f_m)^{4/3} \quad (39)$$

It can be seen in Fig. 8 that this minimum radial error criterion allows for a much smaller radius of curvature than the minimum IAE criterion, and is slightly smaller than that which can be obtained with the Sampled-Data technique using the same criterion:

As a general rule of thumb, the damping factor for optimal dynamic performance of many control systems is considered to be $\zeta = 0.707$. The locus corresponding to this damping factor is included in Fig. 6 for comparison with the design recommendations according to the present optimization criteria. It can be seen that the minimum radial error criterion gives an open-loop gain with the Sampled-Data technique that is almost identical to the value for $\zeta = 0.707$, and with the Reference-Pulse technique ($T = 0$) an open-loop gain that is identical ($K\tau = 0.5$) in both cases. Therefore, designing the CNC system according to the minimum radial error criterion will also insure that the damping factor is optimal.

Summary of Design Considerations

The Reference-Pulse and Sampled-Data CNC control techniques for manufacturing systems have been described and analyzed. The Reference-Pulse technique is much simpler to program, but there is a restriction on the maximum velocity imposed by the control program execution time. By contrast, the maximum velocity in Sampled-Data systems is not limited by the computer, but the control program is more complex and its interpolator routine requires substantial core-memory.

The basis for selecting the appropriate CNC technique is summarized in Fig. 9 which is based on equations (2) and (27). The parameter f_m is proportional to the required maximum velocity limit in CNC systems. For $f_m > 10^4$ only the Sampled-Data technique is applicable, whereas for $f_m < 10^4$ the Reference-Pulse technique is required for a short time constant and either technique can be used for a long time constant. Given the choice, the Reference-Pulse technique is preferred because of its simplicity.

For designing a Reference-Pulse system, the main parameter is the open-loop gain K and its optimal value is given in equation (11) as $K = 1/(2\tau)$. Sampled-Data systems require the consideration of two main parameters: the sampling period and the open-loop gain. The sampling period T depends on the time constant τ of the drive and its recommended value according to equation (23) is $T \approx 0.8\tau$. Selection of the open loop gain depends upon the required motion. For linear motions, the minimum IAE has been chosen as a suitable criterion

for optimization and the relationships between the loop gain and the computer sampling period is given by the IAE locus in Fig. 6. For combined linear and circular motions, the minimum radial error in circular motions has been proposed as the performance criterion, and the relationship between the optimal loop gain and the computer sampling period from equation (35) is:

$$K = \frac{1}{T + 2\tau} \quad (40)$$

Applying this optimal relationship results in a damping factor of $\zeta \approx 0.7$, which leads to satisfactory response to both step and sinusoidal inputs.

To illustrate the design procedure, consider a CNC drive system for a machine tool with a time constant $\tau = 20$ msec, a resolution BLU = $5\mu\text{m}$ and a maximum velocity requirement $V_m = 40$ mm/sec. Using equation (1), the pulse frequency is $f_m = 8000$ pulses/sec which, according to Fig. 9 means that either of the two CNC techniques can be applied. With the Reference-Pulse technique, the open-loop gain from equation (11) is $K = 1/2\tau = 25 \text{ sec}^{-1}$. The minimum allowable radius at the maximum velocity is determined from Fig. 8 as $r/BLU = 1.4 \cdot 10^3$ or $r = 7$ mm.

Using the Sampled-Data technique, the sampling period is determined from equation (23) as $T \approx 16$ msec, or a sampling frequency $f_s = 1/T = 62.5$ Hz. The sampling frequency in the system is selected as 64 Hz so as to correspond to a power of 2 (i.e., $2^6 = 64$) to simplify the interpolator routine. With the "min e_r " criterion, for combined linear and circular motions, substituting the values of T and τ into equation (40) results in a gain of $K = 18 \text{ sec}^{-1}$ which, as expected, is smaller than the value of 25 sec^{-1} obtained for the Reference-Pulse counterpart system. The corresponding damping factor calculated from equation (19) is $\zeta = 0.704$. From Fig. 8, the minimum allowable radius at the maximum velocity is $r = 8$ mm.

The step response of the Reference-Pulse system is similar to that of a second-order continuous system, which for our example is:

$$W(t) = V[1 - e^{-25t}(\cos 25t + \sin 25t)] \quad (41)$$

The step response of the Sampled-Data system is obtained from equation (16) as

$$W(n) = V[1 - e^{-0.323n}(\cos 0.326n + 0.983 \sin 0.326n)] \quad (42)$$

For comparing these two responses, substitute $t = nT$ in equation (41), which for the Reference-Pulse system gives:

$$W(n) = V[1 - e^{-0.391n}(\cos 0.391n + \sin 0.391n)] \quad (43)$$

Equations (42) and (43) are almost identical, so that both the Reference-Pulse and Sampled-Data techniques should give virtually the same response. Since the Reference-Pulse technique is simpler to implement, it should be selected for this application.

Acknowledgment

The author would like to thank Professor S. Malkin for his detailed comments and helpful suggestions.

References

- 1 Koren, Y., "Computer-Based Machine-Tool Control," *IEEE Spectrum*, Vol. 14, No. 3, March 1977, pp. 80-84.
- 2 Koren, Y., Shani, A., Ben-Uri, J., "Numerical Control of a Lathe," *IEEE Trans. Ind. & Gen. App.*, Vol. 6, No. 2 March 1970, pp. 175-179.
- 3 Koren, Y., "Design of a Digital Loop for NC," *IEEE Trans. Ind. Elec. & Control Inst.*, Vol. IECI-25, No. 3, Aug. 1978.
- 4 Ertell, G., *Numerical Control*. Wiley-Int. New York, 1969.
- 5 Koren, Y., "Design Concepts of a CNC System," *IEEE-Ind. App. Soc., 10th Ann. Meeting*, Atlanta, Oct. 1975, Proc. pp. 275-282.
- 6 Koren, Y., "Resolver in Digital Control Loop," *IEEE Trans. Ind. Elec. & Control Inst.*, Vol. IECI-24, No. 2, May 1977, pp. 145-149.
- 7 Masory, O., Koren, Y., and Shachrai, A., "CNC Systems for a Laser-Beam Cutter," presented in the *CIRP-10th Int. Sem. on Mfg. systems*, Haifa July 1978.
- 8 Poo, A. N., and Bollinger, J. G., "Digital-analog Servo System Design for CNC," *IEEE Ind. App. Soc. 9th Ann. Meeting*, Oct. 1974.
- 9 Middleditch, A. E., and Paul, F. A., "Dynamic Performance of a CNC

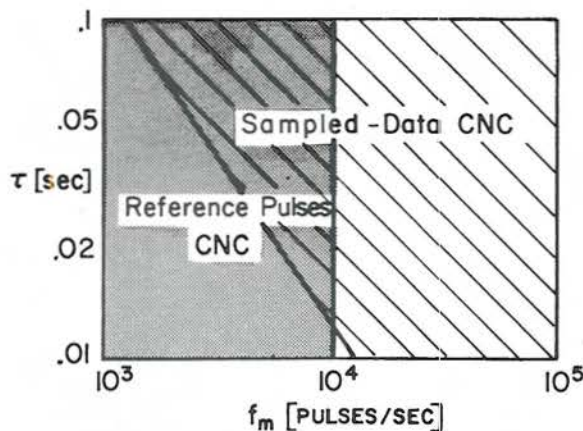

Fig. 9 Diagram for Selection of appropriate CNC technique

System for Multi-Axis Contouring Machine Tools," *ASME publication No. 73-WA/Aut-13*, 1973.

10 Koren, Y., and Bollinger, J. G., "Design Parameters for Sampled-Data Drives for CNC Machine Tools" *IEEE Trans. Ind. App.*, Vol. IA-14, No. 3, May 1978, pp. 255-264

11 Cadzow J. A., *Discrete-Time Systems*. Prentice-Hall, New Jersey, 1973.

12 Poo, A., Bollinger, J. G., and Younkin, W., "Dynamic Errors in Type 1 Contouring Systems," *IEEE Trans. Ind. App.*, Vol. IA-8, No. 4, 1972, pp. 477-484.